

Article number: 437900125

Description: Rota-fix shaft-hub connection SA 125

Measures

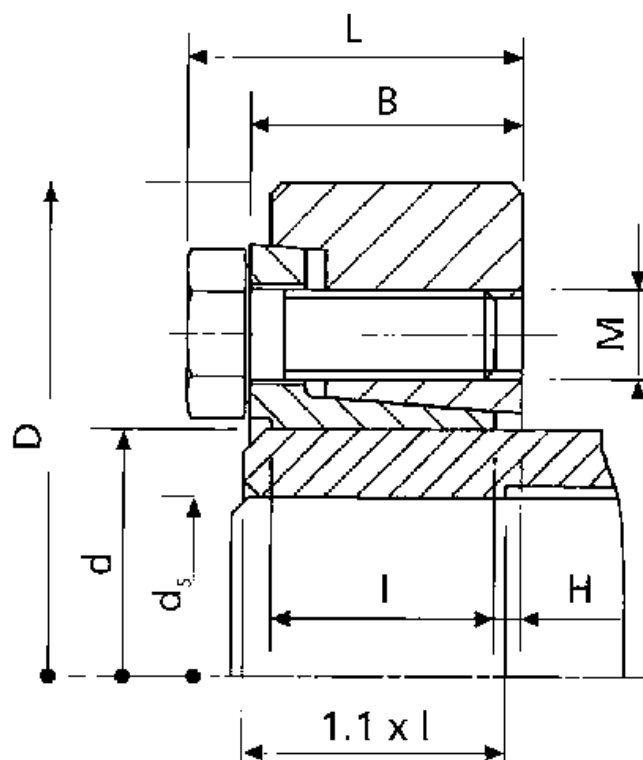

B mm	= 53.5
d H8 mm	= 125
D mm	= 215.0
ds mm	= 90
F kN torque	= 322
H	= 5.5
I mm	= 45.0
L mm	= 61.5

M mm	= M12
T N m torque	= 14500
Ts N m bolt tightening torque	= 100